

# REVOLVING

## POWER M2

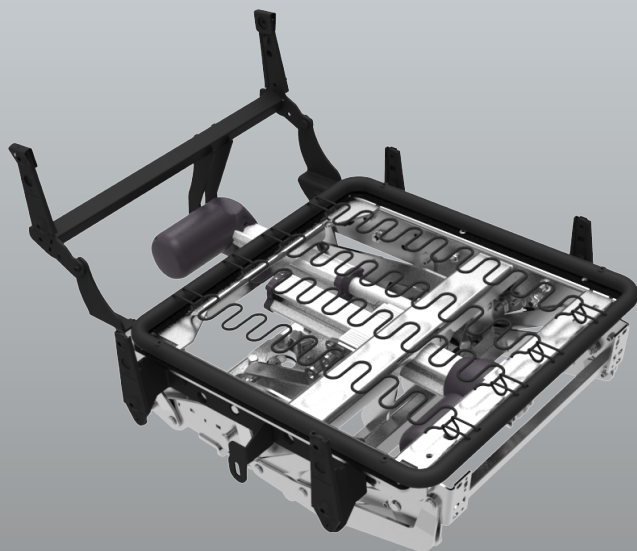

full optional example (CLOSED position) for illustrative purposes



Made in Italy



-  Motorized
-  Sitting  
17kg +/- 2kg
-  Armchair
-  **MAX**  
150kg  
330lbs  
Maximum capacity
-  Cycles: 30.000
- 2 YEARS**  
Mechanism  
**2 YEARS**  
Actuator  
Warranty

**Benefit:** REVOLVING POWER M2 is a versatile mechanism designed for the creation of modern and compact armchairs. The trapezoidal vacuum seat allows the designer to create finished products with various shapes, from classic to contemporary. Two motors allow you to reach the closed positions, tv and full relax, obtaining maximum comfort.

REVOLVING POWER M2 is configurable, various options are available and give the possibility to the end customer to have a customized product according to their needs.

### Positions:













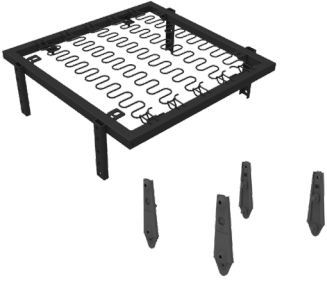
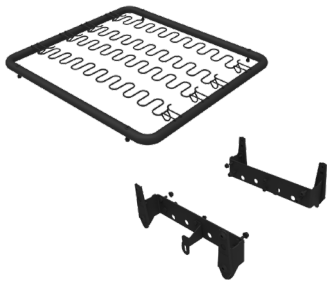
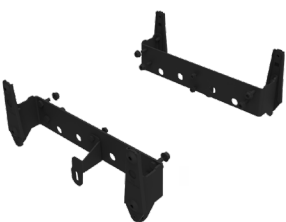

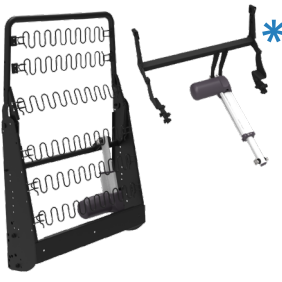
Closed

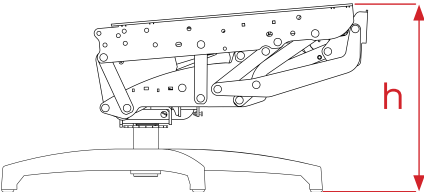

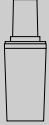



TV





Full Relax





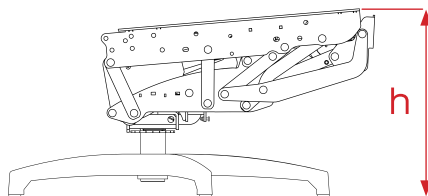











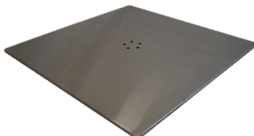
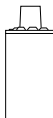
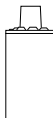





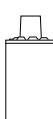

COMPONENTS/OPTIONAL SITTING			
REVOLVING - SEAT	TRAPEZOIDAL SEAT & ARMRESTS KD KIT	STANDARD SEAT & PARALLEL ARMRESTS KIT	PARALLEL ARMRESTS KIT
 <p><b>PR08511-MO-XX</b></p> <p>Finishes: ● AA (shiny black) ● GP (chrome grey) ○ CW (antimicrobial white)</p>	 <p>SEAT <b>MOCO08551-BP</b></p> <p>ARMREST KIT <b>PR08577-AA</b> (OPTIONAL ONLY COMPATIBLE WITH MOCO08551-BP)</p>	 <p>SEAT <b>MOCO05382</b></p> <p>ARMREST KIT <b>PR08553-AA</b></p>	 <p><b>PR08553-AA</b></p> <p>(OPTIONAL COMPATIBLE WITH ALL SITTINGS EXCEPT PR08551-AA)</p>
COMPONENTS/OPTIONAL BACKREST			
PREASSEMBLABLE BACKREST WITH KD ON WOODFRAME	QUICKLY FASTENING BACKREST	DORSAL BACKREST	PREASSEMBLABLE HIGHT BACKREST ON WOODFRAME
 <p><b>PR08882-MO-BP</b></p>	 <p><b>PR08549-MO-AA</b></p>	 <p><b>PR07820-MO-AAP</b></p> <p>(TO INSTALL PR07820-MO-AAP IS REQUIRED PR08549-MO-AA)</p>	 <p><b>MOCO08506-MO-BP</b></p>
BASE COMBINATIONS AND CONICAL PINS			
		<p>□ = recommended pins for a padded seat height between 44-46cm</p> <p>■ = recommended pins for higher seat height between 48-52cm</p>	
BASE	CONICAL PINS		
 <p><b>MOBA0137</b> (Satin chrome)</p>	 <p><b>MOBACO06608</b> hs= 370 mm</p>	 <p><b>MOBACO06617</b> hs= 380 mm</p>	 <p><b>MOBACO06609</b> hs= 390 mm</p>
 <p><b>MOBA0135</b> (Polished)</p> <p><b>MOBA0135-BS</b> (RAL9005)</p>	 <p><b>MOBACO06608</b> hs= 375 mm</p>	 <p><b>MOBACO06617</b> hs= 385 mm</p>	 <p><b>MOBACO06609</b> hs= 395 mm</p>

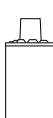
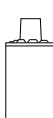
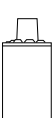
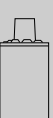



 <b>MOBA07599OP</b> (Mat black)	 <b>MOBACO06608</b> hs= 375 mm	 <b>MOBACO06617</b> hs= 385 mm	 <b>MOBACO06609</b> hs= 395 mm
--	---	---	---

**BASE COMBINATIONS AND EXTRUDED PINS**



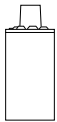

-  = recommended pins for a padded seat height between **44-46cm**
-  = recommended pins for higher seat height between **48-52cm**

BASE	EXTRUDED PINS				
 <b>MOBA0129</b> (MDF)	 <b>MOBACO2481</b> hs= 365 mm	 <b>MOBACO2167</b> hs= 400 mm	 <b>MOBACO1968</b> hs= 410 mm	 <b>MOBACO1763</b> hs= 420 mm	 <b>MOBACO2095</b> hs= 430 mm
 <b>MOBA0131</b> (Satin chrome)	 <b>MOBACO2481</b> hs= 330 mm	 <b>MOBACO2167</b> hs= 365 mm	 <b>MOBACO1968</b> hs= 375 mm	 <b>MOBACO1763</b> hs= 385 mm	 <b>MOBACO2095</b> hs= 400 mm
 <b>MOBA0173</b> (Chromed)	 <b>MOBACO2481</b> hs= 330 mm	 <b>MOBACO2167</b> hs= 365 mm	 <b>MOBACO1968</b> hs= 375 mm	 <b>MOBACO1763</b> hs= 385 mm	 <b>MOBACO2095</b> hs= 400 mm
 <b>MOBA0132</b> (Satin chrome) <b>MOBA0132-BP</b> (Nero opaco)	 <b>MOBACO2481</b> hs= 330 mm	 <b>MOBACO2167</b> hs= 365 mm	 <b>MOBACO1968</b> hs= 375 mm	 <b>MOBACO1763</b> hs= 385 mm	 <b>MOBACO2095</b> hs= 400 mm
 <b>MOBA0176</b> (Chromed)	 <b>MOBACO2481</b> hs= 330 mm	 <b>MOBACO2167</b> hs= 365 mm	 <b>MOBACO1968</b> hs= 375 mm	 <b>MOBACO1763</b> hs= 385 mm	 <b>MOBACO2095</b> hs= 400 mm

 <b>MOBA2309</b> (anthracite)	 <b>MOBACO2481</b> hs= 375 mm	 <b>MOBACO2167</b> hs= 410 mm	 <b>MOBACO1968</b> hs= 420 mm	 <b>MOBACO1763</b> hs= 430 mm	 <b>MOBACO2095</b> hs= 440 mm
--	--	--	--	--	--

**RECOMMENDED ELECTRIC KIT**

REMOTE CONTROLE	OTHER ELECTRICAL COMPONENTS	REMOTE CONTROL WITH BACKREST DORSAL PRO7820-MO-AAP
 <b>DRIVER</b> Code MOECCO08391	<b>Power Supply</b> Cod. MOPS5341	 <b>DRIVER</b> Code <i>contact the electronic</i>
	<b>Plug - EU Cod. MOPSCO5343</b> configurable according to the type requested (EU, UK, USA...)	
	<b>DC extension cable with front stop (4m)</b> Cod. MOPS2743	
	<b>Embedded connector Cod. MOPSCO2062</b> <small>OPTIONAL - DIFFERENT MODELS AVAILABLE</small>	
	<b>Batteria Cod. MOPS07533</b> <small>OPTIONAL - DIFFERENT MODELS AVAILABLE</small>	
	<b>Polarity inversion connector Code MOECCO08097</b> <small>(NO ENCODER - for backrest actuator)</small>	

Possibility of customization of the electrical kit as needed

**BASIC: DIMENSIONS AND POSITIONINGS TO BE RESPECTED FOR NOT COMPROMISE THE FUNCTIONING OF THE PRODUCT**

